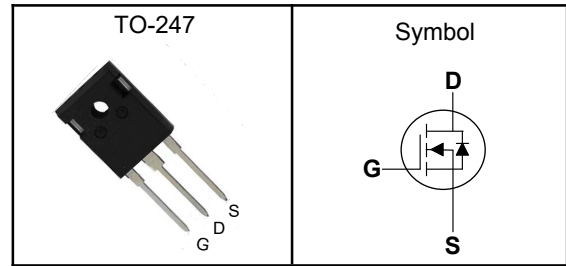

650V Super Junction Power MOSFET
Features

- Low drain-source on-resistance: $R_{DS(ON)}=0.12\Omega(\text{typ})$
- Easy to control gate switching
- Enhancement mode: $V_{th} = 2.5$ to $4.5V$
- 100% avalanche tested
- RoHS compliant

Applications

- Switch Mode Power Supply (SMPS)
- Uninterruptible Power Supply (UPS)
- Power Factor Correction (PFC)
- Charger, Lighting

Pin Description

V_{DSS}	650	V
$R_{DS(ON)-Typ}$	120	m Ω
I_D	24	A

Absolute Maximum Ratings ($T_C=25^\circ C$, Unless Otherwise Noted)

Symbol	Parameter	Rating	Unit
V_{DSS}	Drain-Source Voltage	650	V
V_{GSS}	Gate-Source Voltage	± 30	V
T_J	Maximum Junction Temperature	-55 to 150	$^\circ C$
T_{STG}	Storage Temperature Range	-55 to 150	$^\circ C$
E_{AS}	Single Pulse Avalanche Energy ³	455	mJ
$I_{DM}^{(1)}$	300 μs Pulse Drain Current Tested	72	A
I_D	Continuous Drain Current	24	A
P_D	Maximum Power Dissipation	192	W
I_{AS}	Avalanche Current	3.9	A
dv/dt	MOSFET dv/dt ruggedness, $V_{DS} = 0 \dots 400V$	50	V/ns
	Reverse diode dv/dt ³ $V_{DS}=0 \dots 400V, I_{SD} \leq I_D$	100	

Thermal Characteristics

Symbol	Parameter	Rating	Unit
$R_{\theta JA}^{(3)}$	Thermal Resistance Junction-Ambient ¹ (Max)	40	$^\circ C/W$
$R_{\theta JC}$	Thermal Resistance Junction-Case ¹ (Max)	0.65	$^\circ C/W$

Note ① : Max. current is limited by bonding wire.

Note ② : UIS tested and pulse width are limited by maximum junction temperature $150^\circ C$.

Note ③ : Surface Mounted on $1in^2$ FR-4 board with 1oz.

**650V Super Junction Power MOSFET****Electrical Characteristics** ($T_J=25^\circ\text{C}$, Unless Otherwise Noted)

Symbol	Parameter	Test Conditions	Min	Typ	Max	Unit
Static Electrical Characteristics						
BV_{DSS}	Drain-Source Breakdown Voltage	$V_{GS}=0V, I_D=250\mu A$	650	---	---	V
I_{DSS}	Zero Gate Voltage Drain Current	$V_{DS}=600V, V_{GS}=0V$	---	---	10	μA
$V_{GS(th)}$	Gate Threshold Voltage	$V_{DS}=V_{GS}, I_D=250\mu A$	2.5	---	4.5	V
I_{GSS}	Gate Leakage Current	$V_{GS}=\pm 30V, V_{DS}=0V$	---	---	± 100	nA
$R_{DS(ON)}$	Drain-Source On-state Resistance	$V_{GS}=10V, I_D=12A$	---	120	135	m Ω
Dynamic Characteristics ^⑤						
C_{iss}	Input Capacitance	$V_{GS}=0V,$ $V_{DS}=100V,$ Freq.=1MHz	---	2072	---	pF
C_{oss}	Output Capacitance		---	101	---	
C_{rss}	Reverse Transfer Capacitance		---	1.3	---	
$T_{d(on)}$	Turn-on Delay Time	$V_{DD}=400V, V_{GS}=10V,$ $R_G=4.7\Omega, I_D=12A$	---	21	---	nS
T_r	Turn-on Rise Time		---	40	---	
$T_{d(off)}$	Turn-off Delay Time		---	56	---	
T_f	Turn-off Fall Time		---	14	---	
R_g	Gate Resistance	$f = 1.0\text{MHz}, \text{open drain}$	---	1.9	---	Ω
Q_g	Total Gate Charge	$V_{DS}=400V, V_{GS}=10V,$ $I_D=12A$	---	46	---	nC
Q_{gs}	Gate-Source Charge		---	8	---	
Q_{gd}	Gate-Drain Charge		---	15	---	
Source-Drain Characteristics ($T_J=25^\circ\text{C}$)						
V_{SD} ^④	Diode Forward Voltage	$I_S=12A, V_{GS}=0V$	---	---	1.4	V
t_{rr}	Reverse Recovery Time	$V_R=400V, I_F=12A,$ $di/dt=130A/\mu s, T_J=25^\circ\text{C}$	---	110	---	nS
Q_{rr}	Reverse Recovery Charge		---	0.8	---	nC

Note ④ : Pulse test (pulse width $\leq 300\mu s$, duty cycle $\leq 2\%$).

Note ⑤ : Guaranteed by design, not subject to production testing.

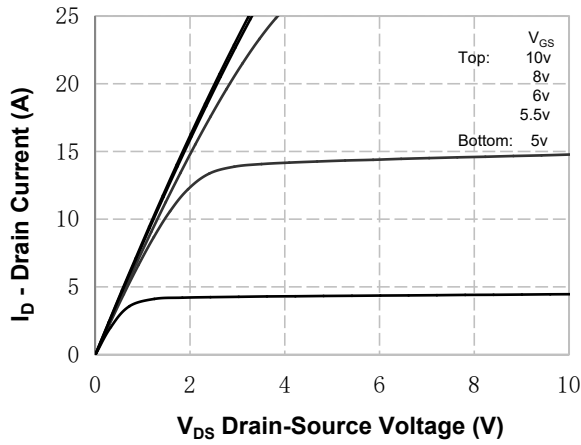
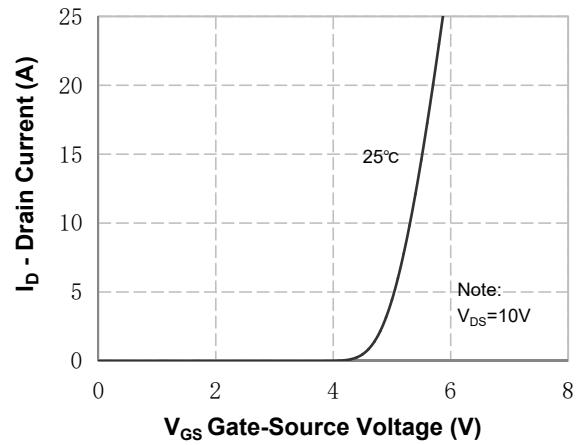
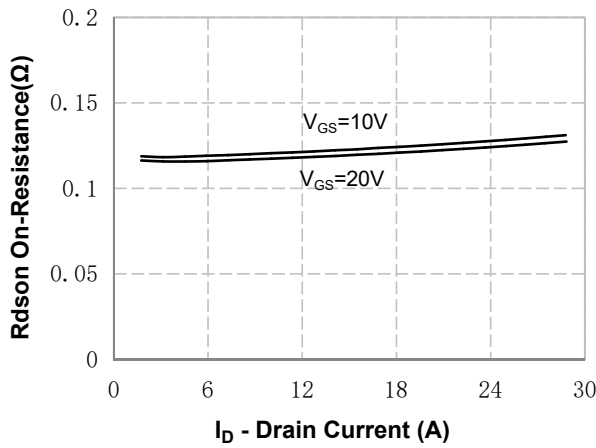
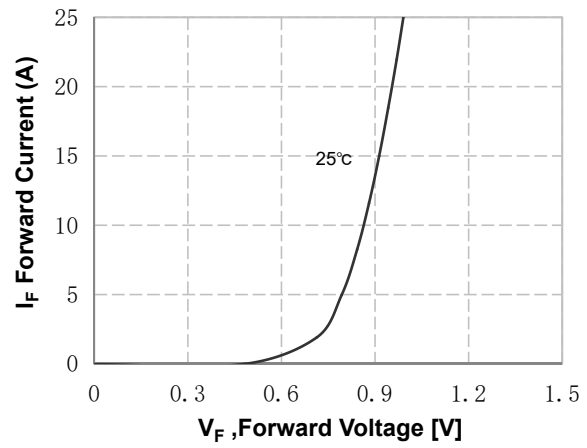
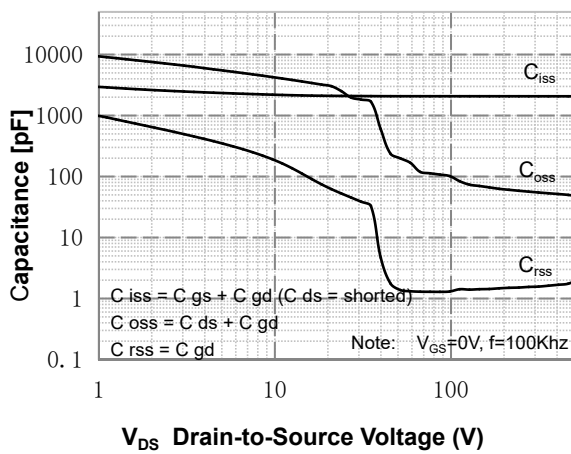
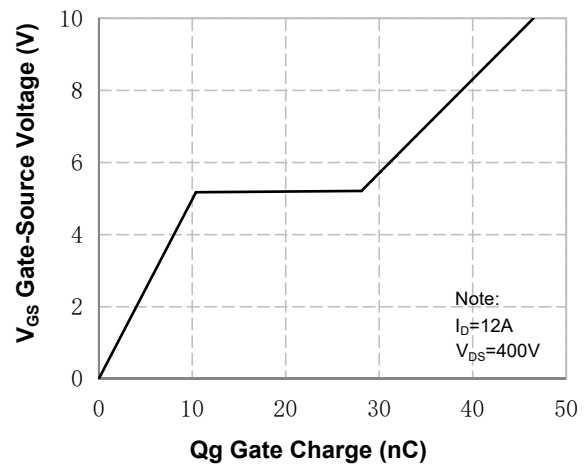
650V Super Junction Power MOSFET
Typical Characteristics

Figure 1. On-Region Characteristics

Figure 2. Transfer Characteristics

Figure 3. On-Resistance Variation vs Drain Current and Gate Voltage

Figure 4. Body Diode Forward Voltage Variation with Source Current

Figure 5. Capacitance Characteristics

Figure 6. Gate Charge Characteristics

650V Super Junction Power MOSFET

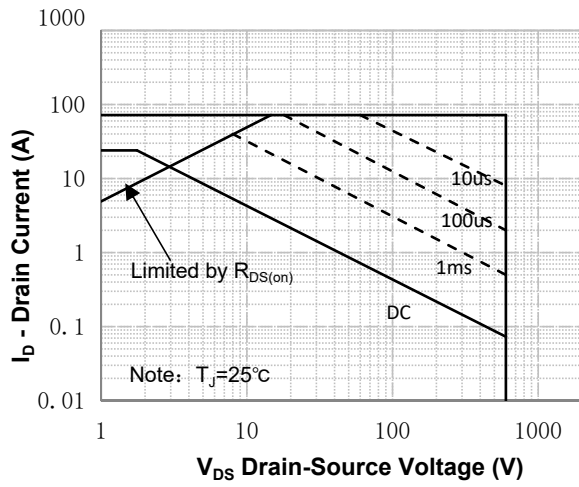

Figure 7. Maximum Safe Operating Area

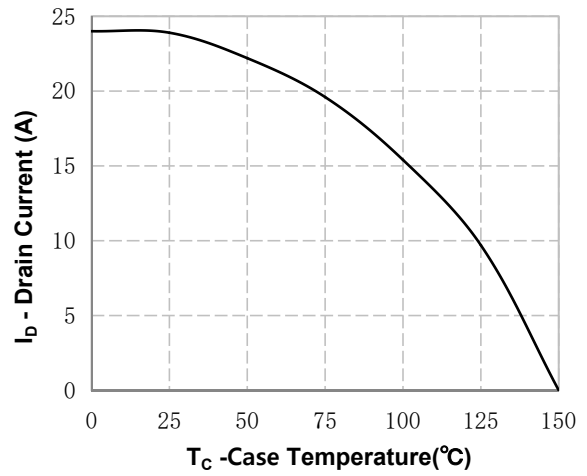

Figure 8. Maximum Drain Current vs Case Temperature

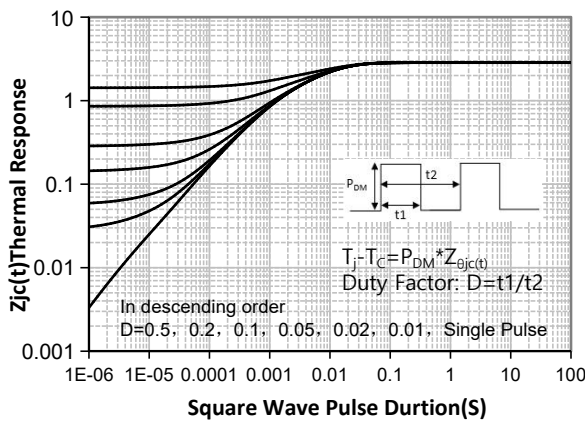
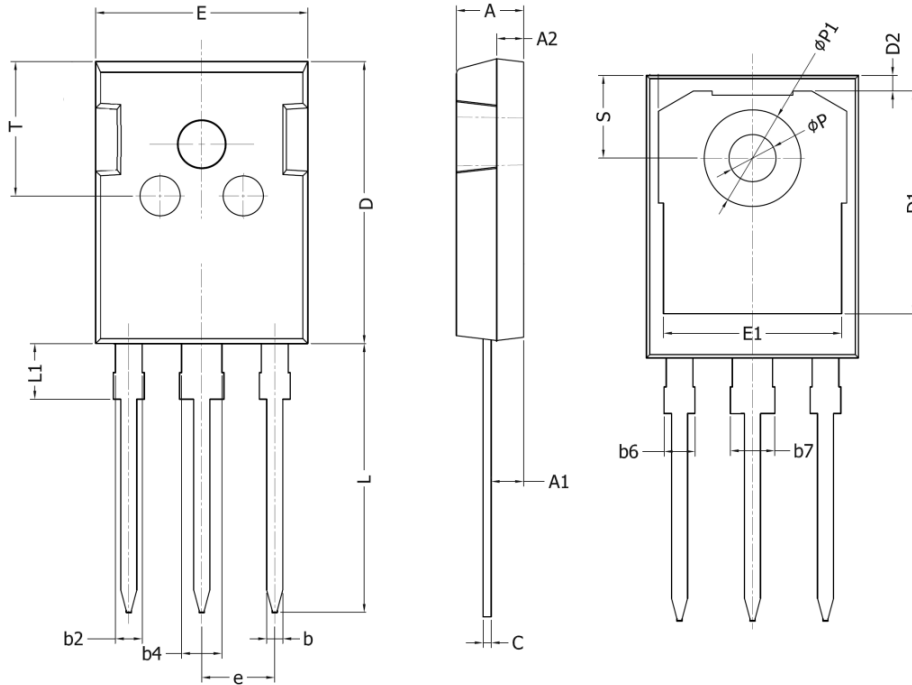

Figure 9. Transient Thermal Response Curve

650V Super Junction Power MOSFET
TO-247 Package Outline Dimensions

Symbol	Dimensions In Millimeters	
	Min.	Max.
A	4.90	5.20
A1	2.31	2.51
A2	1.9	2.1
b	1.16	1.26
b2	1.96	2.06
b4	2.96	3.06
b6	-	2.25
b7	-	3.25
C	0.59	0.66
D	20.90	21.20
D1	16.25	16.85
D2	1.05	1.35
E	15.75	16.10
E1	13.00	13.60
e	5.436 BSC	
L	19.80	20.20
L1	-	4.30
P	3.40	3.60
P1	7.00	7.40
S	6.05	6.25
T	9.80	10.20