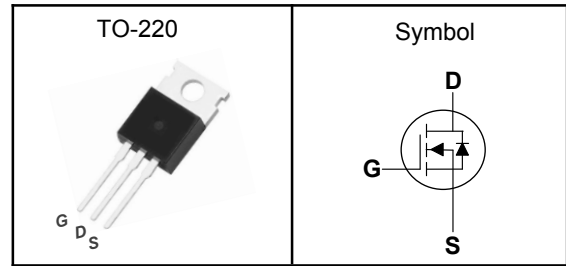

650V Super Junction Power MOSFET
Features

- Low drain-source on-resistance: $R_{DS(ON)}=88m\Omega$ (typ)
- Easy to control gate switching
- Enhancement mode: $V_{th} = 3.0$ to $5.0V$
- 100% avalanche tested
- RoHS compliant

Applications

- Switch Mode Power Supply (SMPS)
- Uninterruptible Power Supply (UPS)
- Power Factor Correction (PFC)
- Charger, Lighting

Pin Description

V_{DSS}	650	V
$R_{DS(ON)-Typ}$	88	m Ω
I_D	38	A

Absolute Maximum Ratings($T_C=25^\circ C$, Unless Otherwise Noted)

Symbol	Parameter	Rating	Unit
V_{DSS}	Drain-Source Voltage	650	V
V_{GSS}	Gate-Source Voltage	± 30	V
T_J	Maximum Junction Temperature	-55 to 150	$^\circ C$
T_{STG}	Storage Temperature Range	-55 to 150	$^\circ C$
E_{AS}	Single Pulse Avalanche Energy ³	180	mJ
$I_{DM}^{①}$	300 μs Pulse Drain Current Tested	140	A
I_D	Continuous Drain Current	38	A
P_D	Maximum Power Dissipation	265	W
I_{AS}	Avalanche Current	5.2	A
dv/dt	MOSFET dv/dt ruggedness, $V_{DS} = 0 \dots 400V$	50	V/ns
	Reverse diode dv/dt ³ $V_{DS}=0 \dots 400V, I_{SD} \leq I_D$	50	

Thermal Characteristics

Symbol	Parameter	Rating	Unit
$R_{\theta JA}^{③}$	Thermal Resistance Junction-Ambient ¹	62.5	$^\circ C/W$
$R_{\theta JC}$	Thermal Resistance Junction-Case ¹	0.47	$^\circ C/W$

Note ① : Max. current is limited by bonding wire.

Note ② : UIS tested and pulse width are limited by maximum junction temperature $150^\circ C$.

Note ③ : Surface Mounted on $1in^2$ FR-4 board with 1oz.

**650V Super Junction Power MOSFET****Electrical Characteristics** ($T_J=25^\circ\text{C}$, Unless Otherwise Noted)

Symbol	Parameter	Test Conditions	Min	Typ	Max	Unit
Static Electrical Characteristics						
BV_{DSS}	Drain-Source Breakdown Voltage	$V_{GS}=0V, I_D=1mA$	650	---	---	V
I_{DSS}	Zero Gate Voltage Drain Current	$V_{DS}=600V, V_{GS}=0V$	---	---	10	μA
$V_{GS(th)}$	Gate Threshold Voltage	$V_{DS}=V_{GS}, I_D=250\mu A$	3.0	---	5.0	V
I_{GSS}	Gate Leakage Current	$V_{GS}=\pm 30V, V_{DS}=0V$	---	---	± 100	nA
$R_{DS(ON)}$	Drain-Source On-state Resistance	$V_{GS}=10V, I_D=17A$	---	88	99	$m\Omega$
Dynamic Characteristics ^⑤						
C_{iss}	Input Capacitance	$V_{GS}=0V,$ $V_{DS}=400V,$ Freq.=1MHz	---	2215	---	pF
C_{oss}	Output Capacitance		---	95	---	
C_{rss}	Reverse Transfer Capacitance		---	8	---	
$T_{d(on)}$	Turn-on Delay Time	$V_{DS}=400V, V_{GS}=10V,$ $R_G=10\Omega, I_D=17A$	---	23	---	nS
T_r	Turn-on Rise Time		---	12	---	
$T_{d(off)}$	Turn-off Delay Time		---	80	---	
T_f	Turn-off Fall Time		---	9	---	
R_g	Gate Resistance	$f = 1.0MHz, \text{open drain}$	---	1.2	---	Ω
Q_g	Total Gate Charge	$V_{DS}=480V,$ $V_{GS}=10V, I_D=17A$	---	56	---	nC
Q_{gs}	Gate-Source Charge		---	18	---	
Q_{gd}	Gate-Drain Charge		---	28	---	
Source-Drain Characteristics ($T_J=25^\circ\text{C}$)						
V_{SD} ^④	Diode Forward Voltage	$I_S=17A, V_{GS}=0V$	---	0.8	1.2	V
t_{rr}	Reverse Recovery Time	$V_{GS}=0V, I_F=17A,$ $di/dt=100A/\mu s, T_J=25^\circ\text{C}$	---	135	---	nS
Q_{rr}	Reverse Recovery Charge		---	0.94	---	nC

Note ④ : Pulse test (pulse width $\leq 300\mu s$, duty cycle $\leq 2\%$).

Note ⑤ : Guaranteed by design, not subject to production testing.

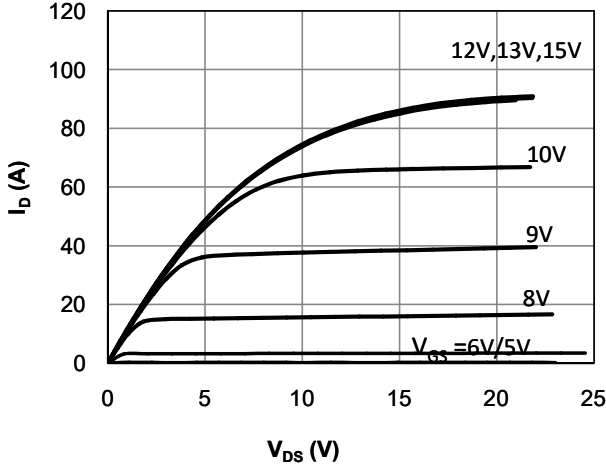
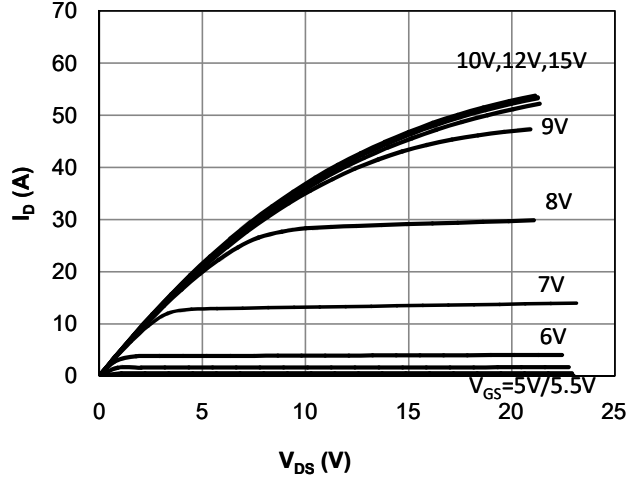
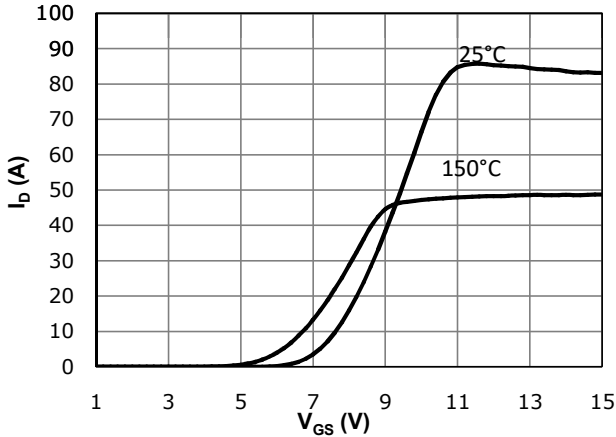
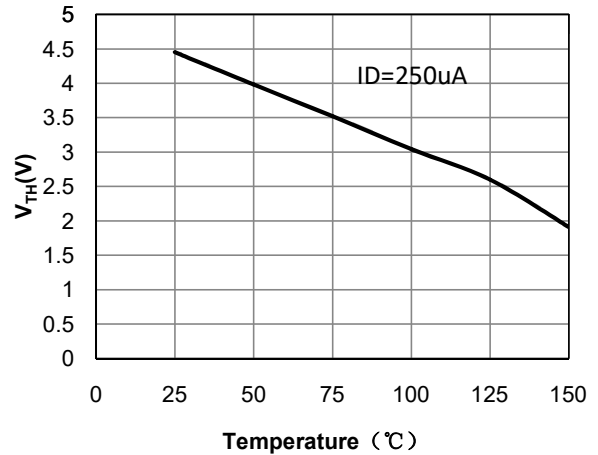
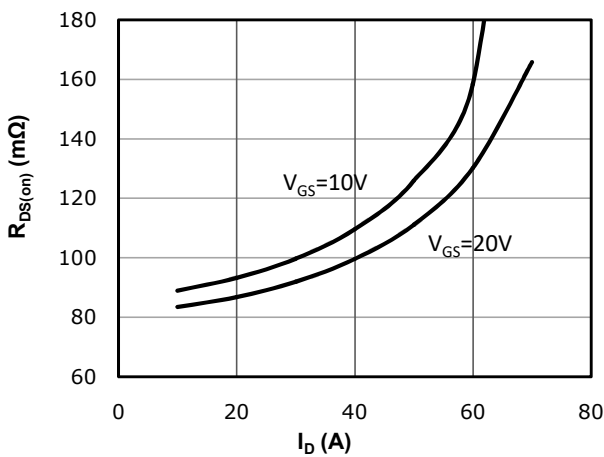
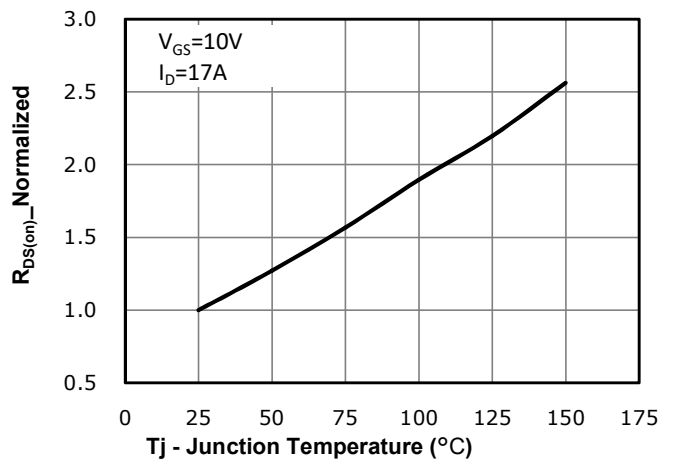
650V Super Junction Power MOSFET
Typical Characteristics
Fig 1. Output Characteristics (Tj=25°C)

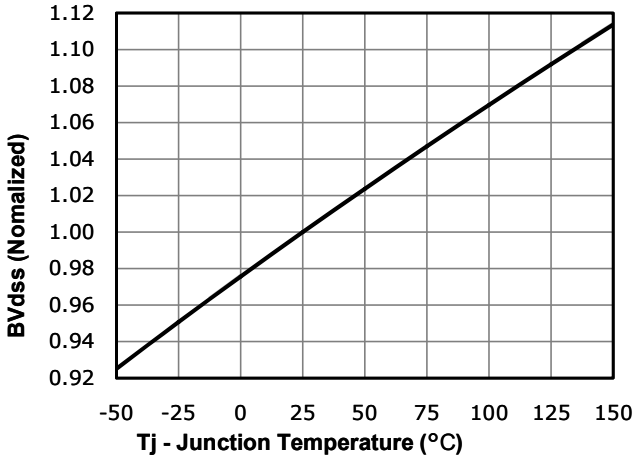
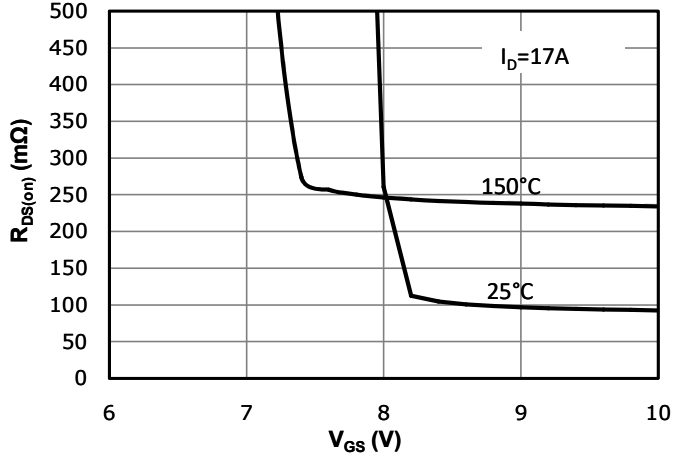
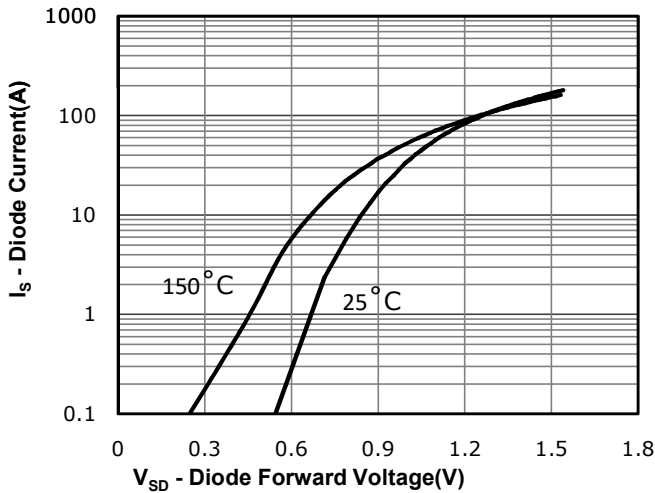
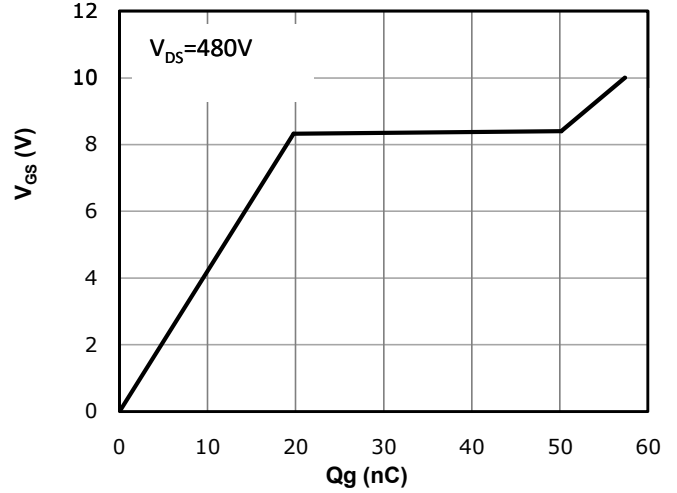
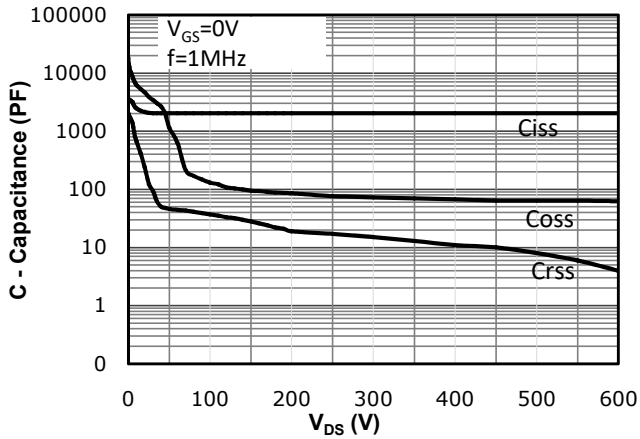
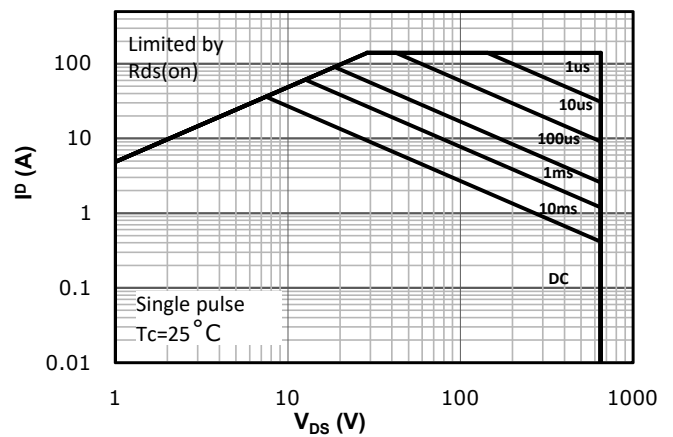
Fig 2. Output Characteristics (Tj=150°C)

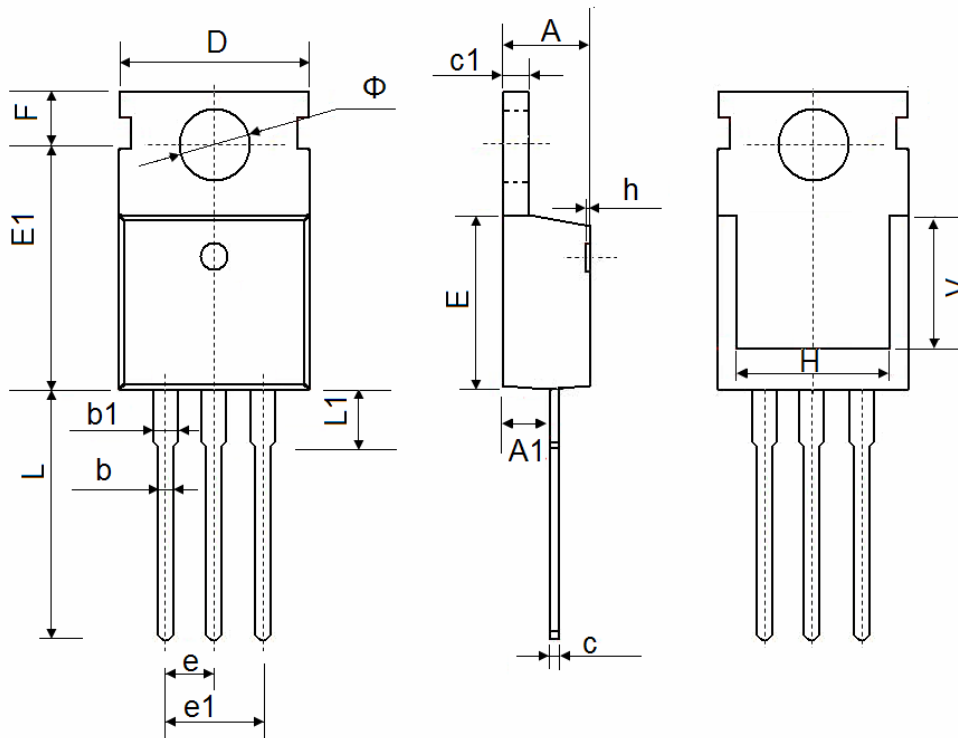
Fig 3: Transfer Characteristics

Fig 4: V_{TH} Vs Tj Temperature Characteristics

Fig 5: R_{DS(on)} Vs Ids Characteristics (Tc=25°C)

Fig 6: R_{DS(on)} vs. Temperature

650V Super Junction Power MOSFET
Fig 7: BVDSS vs. Temperature

Fig 8: Rds(on) vs Gate Voltage

Fig 9: Body-diode Forward Characteristics

Fig 10: Gate Charge Characteristics

Fig 11: Capacitance Characteristics

Fig 12: Safe Operating Area

650V Super Junction Power MOSFET
TO-220 Package Outline Data

Symbol	Dimensions In Millimeters	
	Min.	Max.
A	4.350	4.650
A1	2.250	2.550
b	0.710	0.910
b1	1.170	1.400
c	0.330	0.650
c1	1.200	1.400
D	9.910	10.250
E	8.9500	9.750
E1	12.650	12.950
e	2.540 TYP.	
e1	4.980	5.180
F	2.650	2.950
H	7.900	8.100
h	0.000	0.300
L	12.700	13.500
L1	2.850	3.250
V	7.500 REF.	
Φ	3.400	3.800