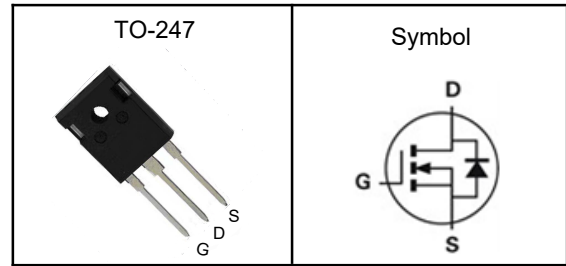

**650V Super Junction Power MOSFET**
**Features**

- Low drain-source on-resistance:  $R_{DS(ON)}=0.082(\Omega_{typ})$
- Very Low FOM ( $R_{DS(on)} \times Q_g$ )
- Extremely low switching loss
- 100% avalanche tested
- RoHS compliant

**Pin Description**

**Applications**

- Switch Mode Power Supply (SMPS)
- Uninterruptible Power Supply (UPS)
- Power Factor Correction (PFC)

$V_{DSS}$	650	V
$R_{DS(ON)-Typ}$	82	m $\Omega$
$I_D$	47	A

**Absolute Maximum Ratings** ( $T_J=25^\circ\text{C}$ , Unless Otherwise Noted)

Symbol	Parameter	N-Channel	Unit
$V_{DSS}$	Drain-Source Voltage	650	V
$V_{GSS}$	Gate-Source Voltage	$\pm 30$	V
$T_J$	Maximum Junction Temperature	-55 to 150	$^\circ\text{C}$
$T_{STG}$	Storage Temperature Range	-55 to 150	$^\circ\text{C}$
$E_{AS}$	Single Pulse Avalanche Energy <sup>3</sup>	1280	mJ
$I_{DM}^{①}$	300 $\mu\text{s}$ Pulse Drain Current Tested	141	A
$I_D$	Continuous Drain Current	$T_C=25^\circ\text{C}$ 47	A
$P_D$	Maximum Power Dissipation	$T_C=25^\circ\text{C}$ 391	W

**Thermal Characteristics**

Symbol	Parameter	Rating	Unit
$R_{\theta JA}$	Thermal Resistance Junction-Ambient <sup>1</sup> (Max)	62	$^\circ\text{C/W}$
$R_{\theta JC}$	Thermal Resistance Junction-Case <sup>1</sup>	0.32	$^\circ\text{C/W}$

Note ① : Max. current is limited by bonding wire.

Note ② : UIS tested and pulse width are limited by maximum junction temperature 150 $^\circ\text{C}$ .

Note ③ : Surface Mounted on 1in<sup>2</sup> FR-4 board with 1oz.

**650V Super Junction Power MOSFET****Electrical Characteristics** ( $T_J=25^\circ\text{C}$ , Unless Otherwise Noted)

Symbol	Parameter	Test Conditions	Min	Typ	Max	Unit
<b>Static Electrical Characteristics</b>						
$BV_{DSS}$	Drain-Source Breakdown Voltage	$V_{GS}=0V, I_D=250mA$	650	---	---	V
$I_{DSS}$	Zero Gate Voltage Drain Current	$V_{DS}=650V, V_{GS}=0V$	---	---	1	$\mu A$
$V_{GS(th)}$	Gate Threshold Voltage	$V_{DS}=V_{GS}, I_D=1.24mA$	3.0	---	4.0	V
$I_{GSS}$	Gate Leakage Current	$V_{GS}=\pm 30V, V_{DS}=0V$	---	---	$\pm 100$	nA
$R_{DS(ON)}$	Drain-Source On-state Resistance	$V_{GS}=10V, I_D=23.5A$	---	82	91	$m\Omega$
<b>Dynamic Characteristics</b> <sup>⑤</sup>						
$C_{iss}$	Input Capacitance	$V_{GS}=0V,$ $V_{DS}=50V,$ Freq.=1MHz	---	3680	---	pF
$C_{oss}$	Output Capacitance		---	390	---	
$C_{riss}$	Reverse Transfer Capacitance		---	15	---	
$T_{d(on)}$	Turn-on Delay Time	$V_{DD}=400V,$ $V_{GS}=13V, R_G=1.9\Omega,$ $I_D=25.8A$	---	15	---	nS
$T_r$	Turn-on Rise Time		---	12	---	
$T_{d(off)}$	Turn-off Delay Time		---	80	---	
$T_f$	Turn-off Fall Time		---	6	---	
$Q_g$	Total Gate Charge	$V_{DS}=480V,$ $V_{GS}=10V, I_D=47A$	---	72	---	nC
$Q_{gs}$	Gate-Source Charge		---	14	---	
$Q_{gd}$	Gate-Drain Charge		---	24	---	
<b>Source-Drain Characteristics</b> ( $T_J=25^\circ\text{C}$ )						
$V_{SD}$ <sup>④</sup>	Diode Forward Voltage	$I_S=47A, V_{GS}=0V$	---	0.9	1.2	V
$t_{rr}$	Reverse Recovery Time	$V_R=400V, I_F=25.8A,$	---	518	---	nS
$Q_{rr}$	Reverse Recovery Charge	$di/dt=100A/\mu s, T_J=25^\circ\text{C}$	---	8	---	nC

Note ④ : Pulse test (pulse width $\leq 300\mu s$ , duty cycles $\leq 2\%$ ).

Note ⑤ : Guaranteed by design, not subject to production testing.

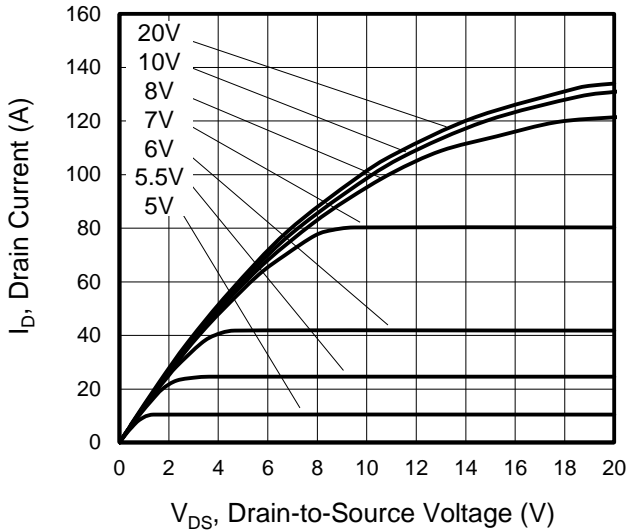
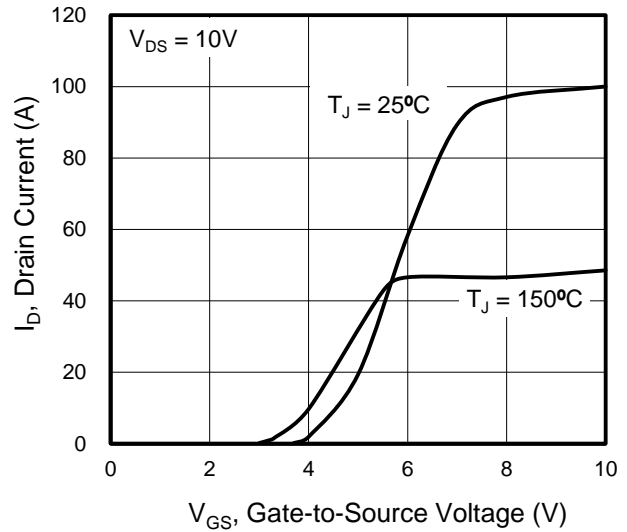
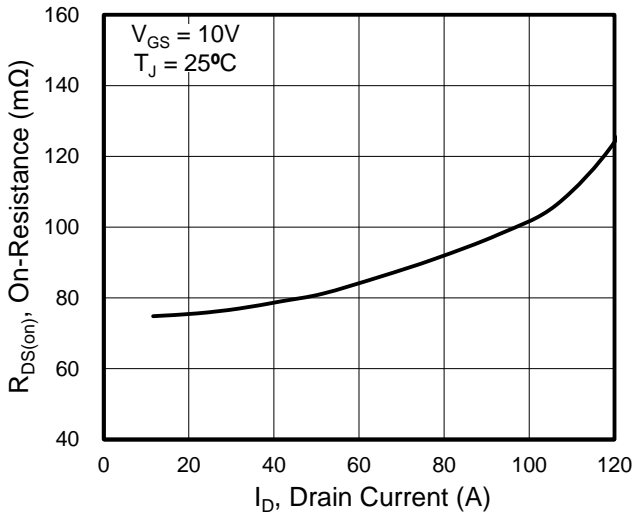
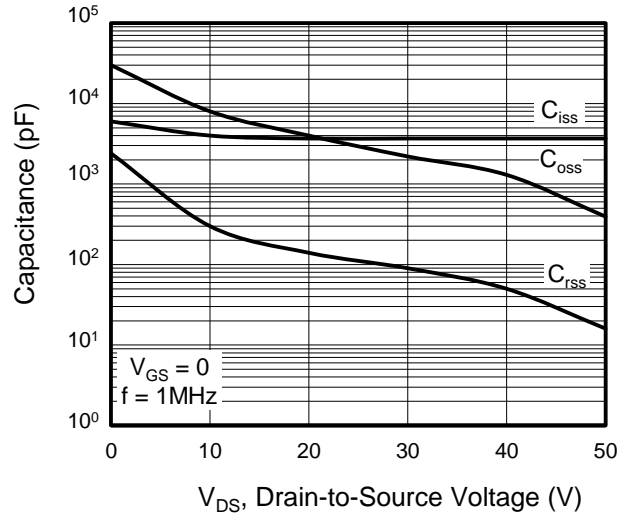
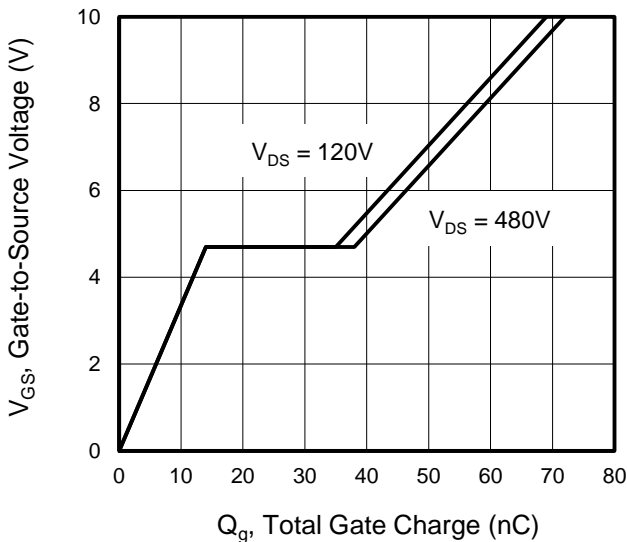
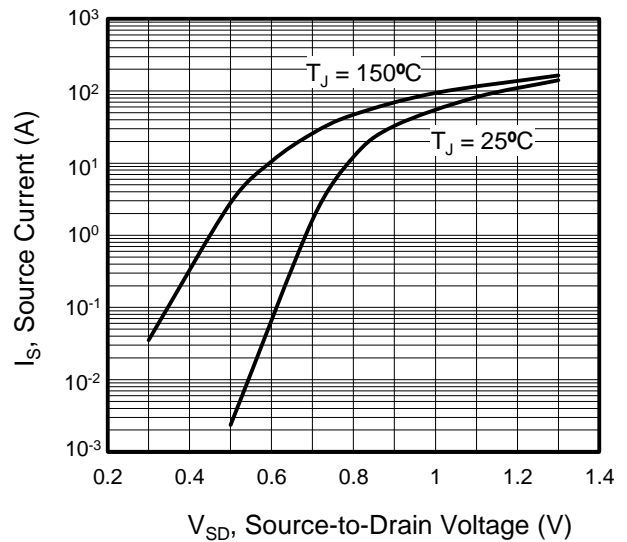
**650V Super Junction Power MOSFET**
**Typical Characteristics**
**Figure 1. Output Characteristics**

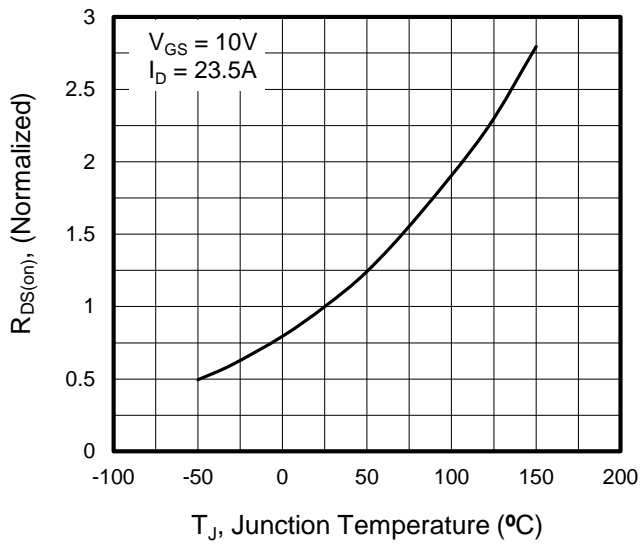
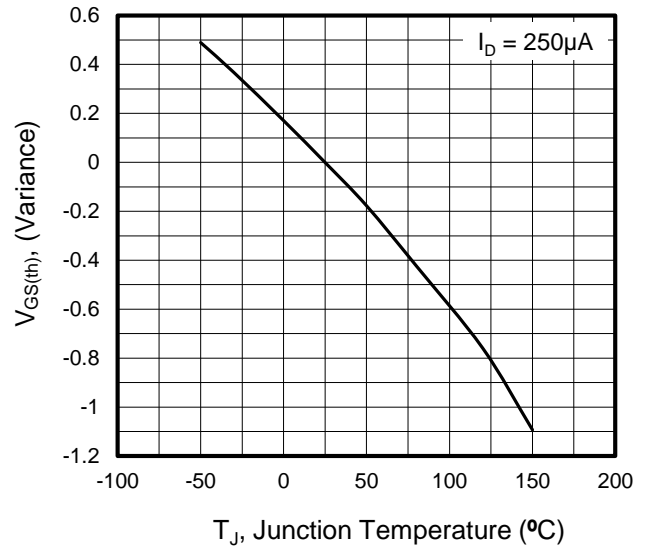
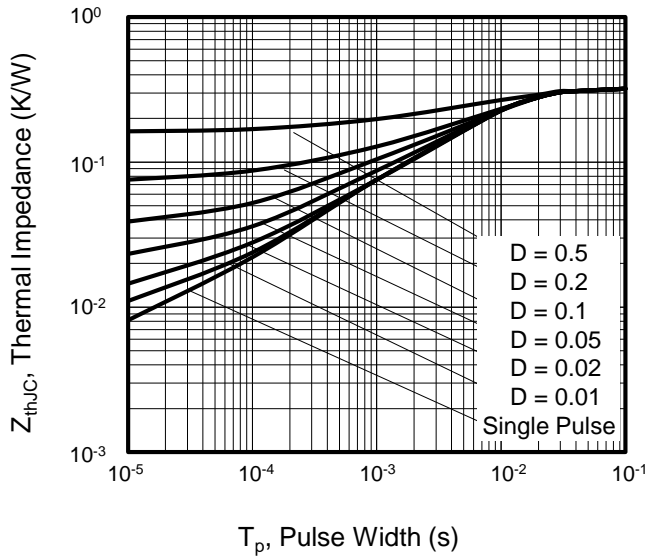
**Figure 2. Transfer Characteristics**

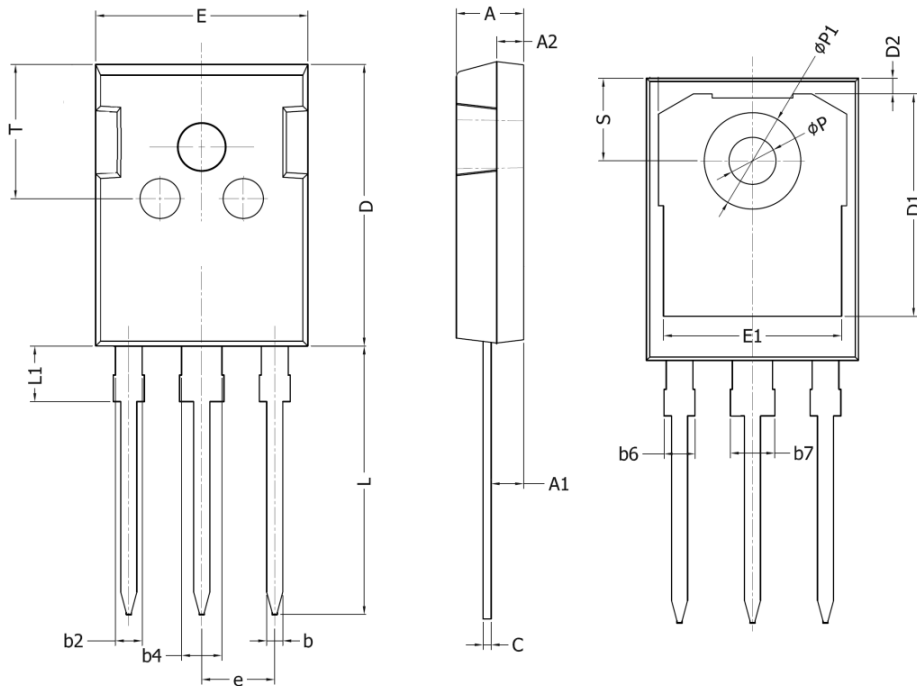
**Figure 3. On-Resistance vs. Drain Current**

**Figure 4. Capacitance**

**Figure 5. Gate Charge**

**Figure 6. Body Diode Forward Voltage**

**650V Super Junction Power MOSFET**
**Figure 7. On-Resistance vs. Temperature**

**Figure 8. Threshold Voltage vs. Temperature**

**Figure 9. Transient Thermal Impedance**

**650V Super Junction Power MOSFET**
**TO-247 Package Outline Dimensions**

Symbol	Dimensions In Millimeters	
	Min.	Max.
A	4.90	5.20
A1	2.31	2.51
A2	1.9	2.1
b	1.16	1.26
b2	1.96	2.06
b4	2.96	3.06
b6	-	2.25
b7	-	3.25
C	0.59	0.66
D	20.90	21.20
D1	16.25	16.85
D2	1.05	1.35
E	15.75	16.10
E1	13.00	13.60
e	5.436 BSC	
L	19.80	20.20
L1	-	4.30
P	3.40	3.60
P1	7.00	7.40
S	6.05	6.25
T	9.80	10.20