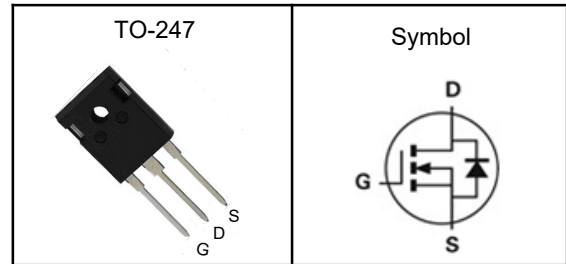

600V Super Junction Power MOSFET
Features

- Low drain-source on-resistance: $R_{DS(ON)}=0.026\Omega(\text{typ})$
- Very Low FOM ($R_{DS(on)} \times Q_g$)
- Extremely low switching loss
- 100% avalanche tested
- RoHS compliant

Pin Description

Applications

- Switch Mode Power Supply (SMPS)
- Uninterruptible Power Supply (UPS)
- Power Factor Correction (PFC)

V_{DSS}	600	V
$R_{DS(ON)-Typ}$	26	m Ω
I_D	75	A

Absolute Maximum Ratings ($T_C=25^\circ\text{C}$, Unless Otherwise Noted)

Symbol	Parameter	N-Channel	Unit
V_{DSS}	Drain-Source Voltage	600	V
V_{GSS}	Gate-Source Voltage	± 30	V
T_J	Maximum Junction Temperature	-55 to 150	$^\circ\text{C}$
T_{STG}	Storage Temperature Range	-55 to 150	$^\circ\text{C}$
E_{AS}	Single Pulse Avalanche Energy ³	1083	mJ
$I_{DM}^{①}$	300 μs Pulse Drain Current Tested	261	A
I_D	Continuous Drain Current	$T_C=25^\circ\text{C}$ 75	A
P_D	Maximum Power Dissipation	$T_C=25^\circ\text{C}$ 568	W

Thermal Characteristics

Symbol	Parameter	Rating	Unit
$R_{\theta JA}$	Thermal Resistance Junction-Ambient ¹ (Max)	40	$^\circ\text{C}/\text{W}$
$R_{\theta JC}$	Thermal Resistance Junction-Case ¹	0.22	$^\circ\text{C}/\text{W}$

Note ① : Max. current is limited by bonding wire.

Note ② : UIS tested and pulse width are limited by maximum junction temperature 150 $^\circ\text{C}$.

Note ③ : Surface Mounted on 1in² FR-4 board with 1oz.

**600V Super Junction Power MOSFET****Electrical Characteristics** ($T_J=25^\circ\text{C}$, Unless Otherwise Noted)

Symbol	Parameter	Test Conditions	Min	Typ	Max	Unit
Static Electrical Characteristics						
BV_{DSS}	Drain-Source Breakdown Voltage	$V_{GS}=0V, I_D=250mA$	600	---	---	V
I_{DSS}	Zero Gate Voltage Drain Current	$V_{DS}=600V, V_{GS}=0V$	---	---	10	μA
$V_{GS(th)}$	Gate Threshold Voltage	$V_{DS}=V_{GS}, I_D=1.44mA$	3	---	5	V
I_{GSS}	Gate Leakage Current	$V_{GS}=\pm 30V, V_{DS}=0V$	---	---	± 100	nA
$R_{DS(ON)}$	Drain-Source On-state Resistance	$V_{GS}=10V, I_D=37.5A$	---	26	30	$m\Omega$
Dynamic Characteristics ^⑤						
C_{iss}	Input Capacitance	$V_{GS}=0V,$ $V_{DS}=400V,$ Freq.=250MHz	---	8520	---	pF
C_{oss}	Output Capacitance		---	192	---	
C_{riss}	Reverse Transfer Capacitance		---	---	---	
$T_{d(on)}$	Turn-on Delay Time	$V_{DS}=400V, V_{GS}=10V,$ $R_G=2.7\Omega, I_D=37.5A$	---	37	---	nS
T_r	Turn-on Rise Time		---	14	---	
$T_{d(off)}$	Turn-off Delay Time		---	127	---	
T_f	Turn-off Fall Time		---	11	---	
Q_g	Total Gate Charge	$V_{DS}=400V,$ $V_{GS}=10V, I_D=37.5A$	---	209	---	nC
Q_{gs}	Gate-Source Charge		---	49	---	
Q_{gd}	Gate-Drain Charge		---	104	---	
Source-Drain Characteristics ($T_J=25^\circ\text{C}$)						
V_{SD} ^④	Diode Forward Voltage	$I_S=37.5A, V_{GS}=0V$	---	0.7	1.2	V
t_{rr}	Reverse Recovery Time	$V_R=400V, I_F=37.5A,$ $di/dt=100A/\mu s, T_J=25^\circ\text{C}$	---	234	---	nS
Q_{rr}	Reverse Recovery Charge		---	2.3	---	nC

Note ④ : Pulse test (pulse width $\leq 300\mu s$, duty cycles $\leq 2\%$).

Note ⑤ : Guaranteed by design, not subject to production testing.

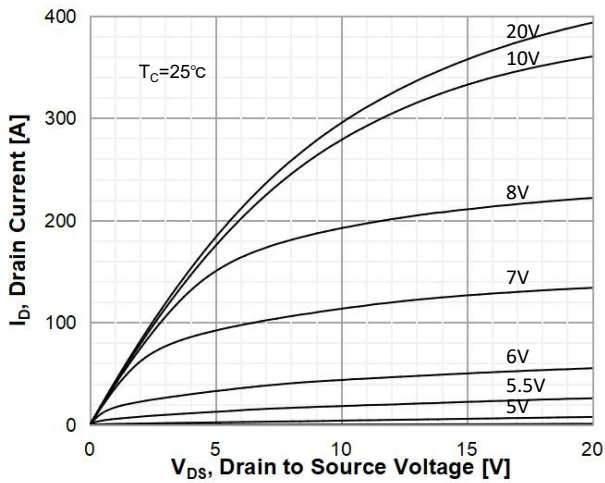
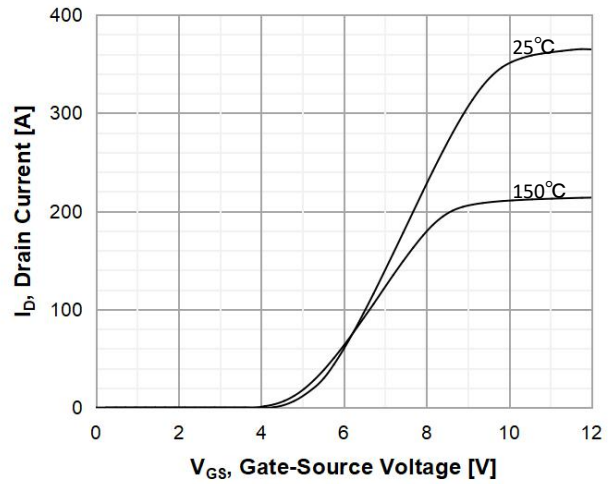
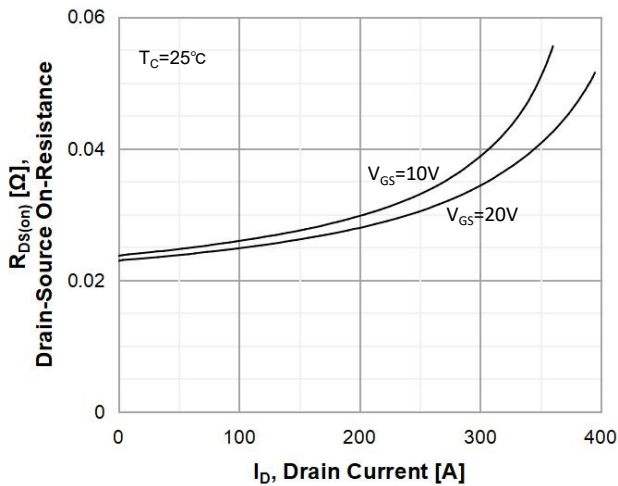
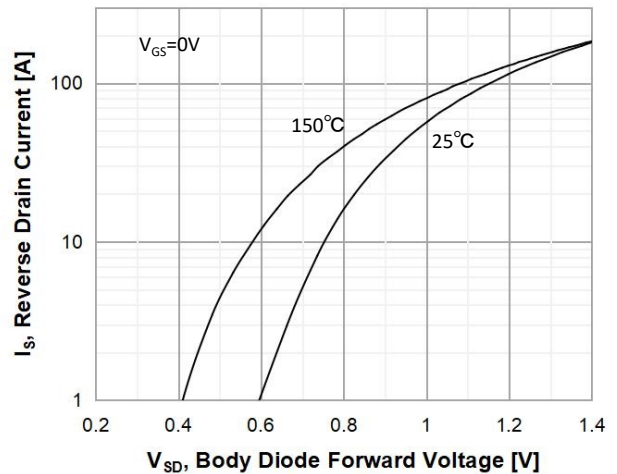
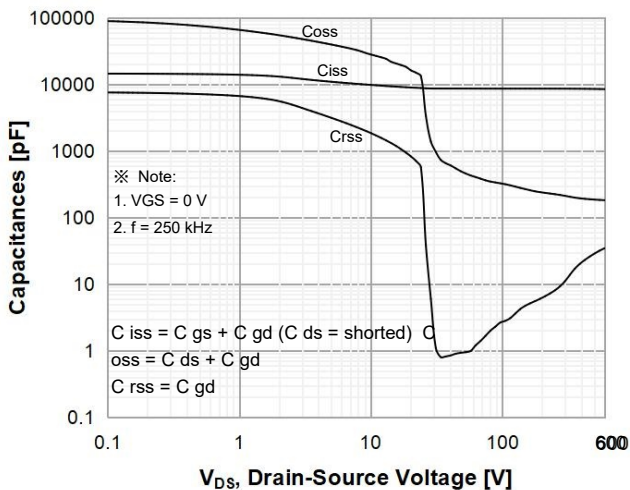
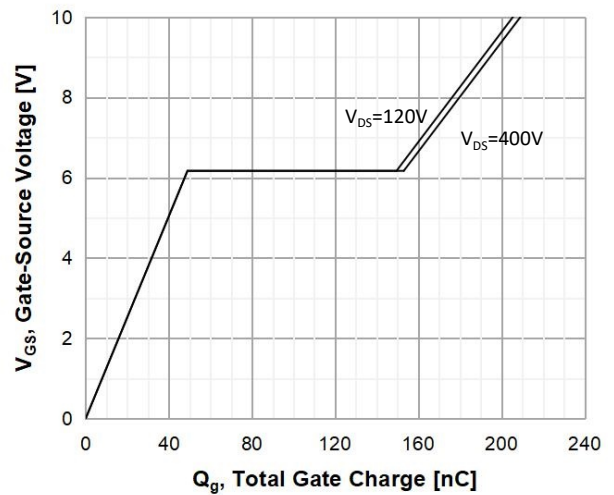
600V Super Junction Power MOSFET
Typical Characteristics

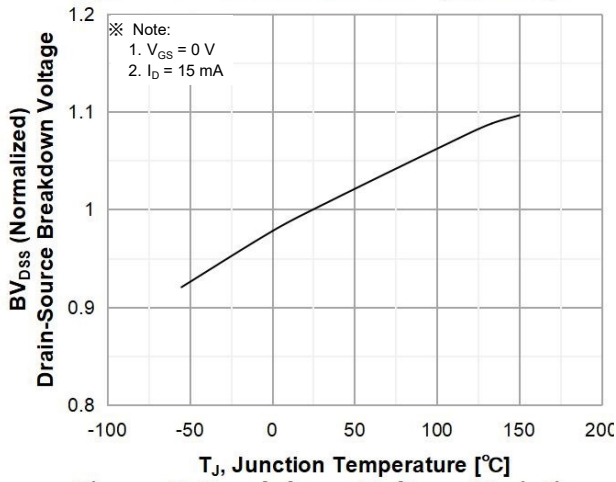
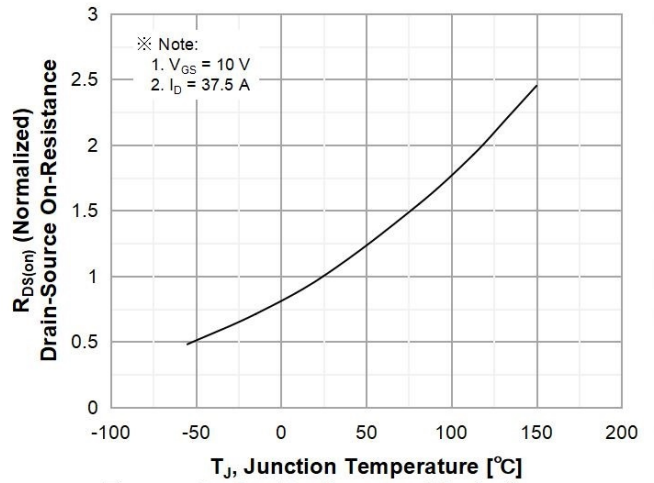
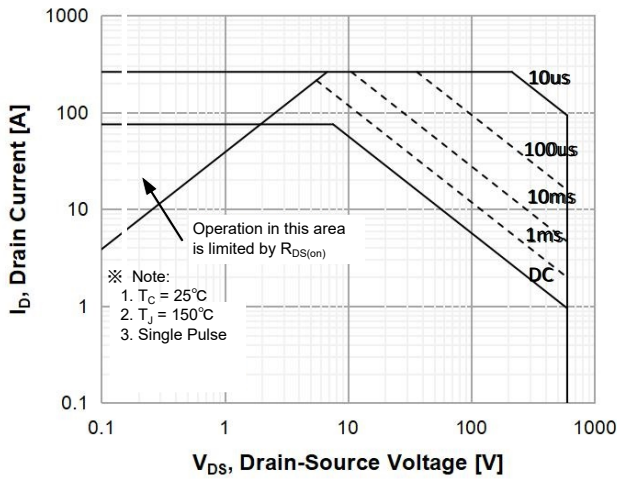
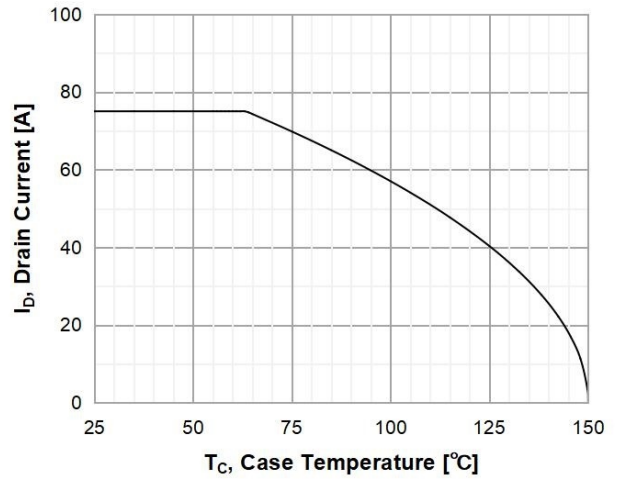
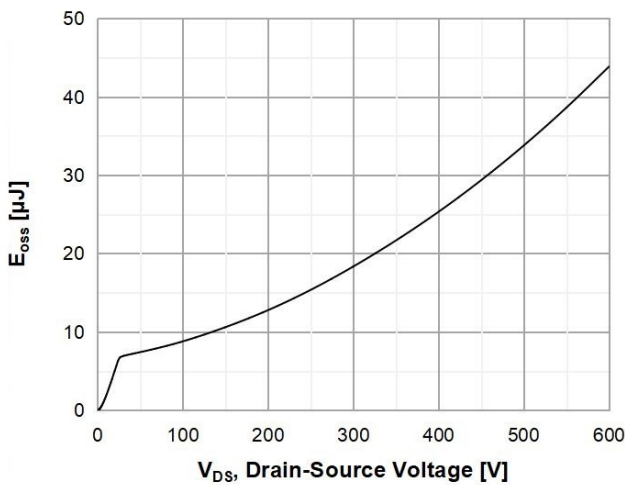
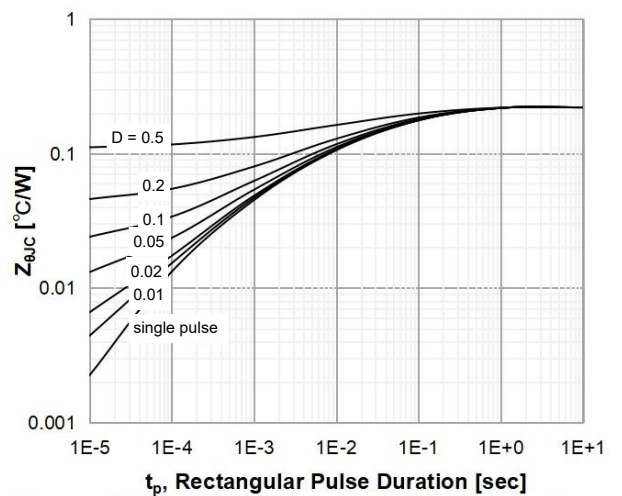
Figure 1. On-Region Characteristics

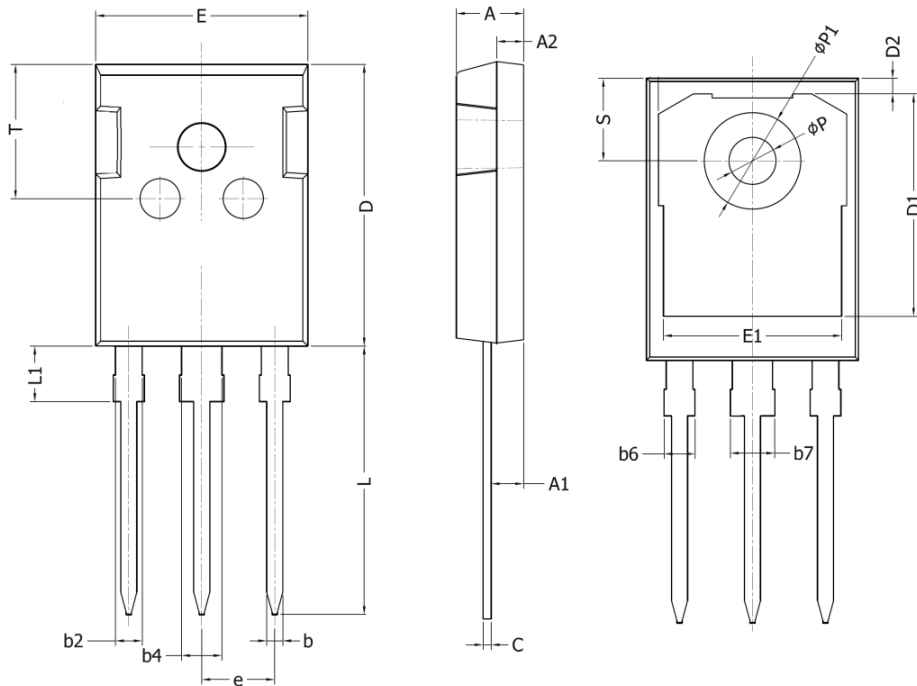
Figure 2. Transfer Characteristics

Figure 3. On-Resistance Variation vs Drain Current and Gate Voltage

Figure 4. Body Diode Forward Voltage Variation with Source Current and Temperature

Figure 5. Capacitance Characteristics

Figure 6. Gate Charge Characteristics

600V Super Junction Power MOSFET

Figure 7. Breakdown Voltage Variation vs Temperature

Figure 8. On-Resistance Variation

Figure 9. Maximum Safe Operating Area

Figure 10. Maximum Drain Current vs. Case Temperature

Figure 11. E_{oss} vs. Drain to Source Voltage

Figure 12. Transient Thermal Response Curve

600V Super Junction Power MOSFET
TO-247 Package Outline Dimensions

Symbol	Dimensions In Millimeters	
	Min.	Max.
A	4.90	5.20
A1	2.31	2.51
A2	1.9	2.1
b	1.16	1.26
b2	1.96	2.06
b4	2.96	3.06
b6	-	2.25
b7	-	3.25
C	0.59	0.66
D	20.90	21.20
D1	16.25	16.85
D2	1.05	1.35
E	15.75	16.10
E1	13.00	13.60
e	5.436 BSC	
L	19.80	20.20
L1	-	4.30
P	3.40	3.60
P1	7.00	7.40
S	6.05	6.25
T	9.80	10.20