

Silicon Carbide Schottky Diode

| | | |
|---------------------------------------|---|-------|
| V_{RRM} | = | 650 V |
| $I_F (T_C=153\text{ }^\circ\text{C})$ | = | 4 A |
| Q_C | = | 11 nC |

Features

- 650 V Schottky Rectifier
- Zero Reverse Recovery Current
- High-Frequency Operation
- Temperature-Independent Switching
- Extremely Fast Switching

Benefits

- Replace Bipolar with Unipolar Rectifiers
- Essentially No Switching Losses
- High Efficiency
- Reduction of Heat Sink Requirements
- Parallel Devices Without Thermal Runaway

Applications

- Switching Mode Power Supply
- Boost Diodes in PFC
- DC/DC Converters
- AC/DC Converters
- Free Wheeling Diodes in Inverter

Maximum Ratings ($T_c = 25\text{ }^\circ\text{C}$ unless otherwise specified)

| Symbol | Parameter | Value | Unit | Test Conditions | Note |
|-----------|--------------------------------------|----------------|------------------|--|--------|
| V_{RRM} | Repetitive Peak Reverse Voltage | 650 | V | | |
| V_{RSM} | Surge Peak Reverse Voltage | 650 | V | | |
| V_R | DC Peak Reverse Voltage | 650 | V | | |
| I_F | Continuous Forward Current | 13 6 4 | A | $T_c=25\text{ }^\circ\text{C}$ $T_c=135\text{ }^\circ\text{C}$ $T_c=153\text{ }^\circ\text{C}$ | Fig. 3 |
| I_{FSM} | Non-Repetitive Forward Surge Current | 34 | A | $T_c=25\text{ }^\circ\text{C}$, $t_p=10\text{ ms}$, Half Sine Pulse | |
| P_{tot} | Power Dissipation | 51 22 | W | $T_c=25\text{ }^\circ\text{C}$ $T_c=110\text{ }^\circ\text{C}$ | Fig. 4 |
| T_J | Operating Junction Range | -55 to +175 | $^\circ\text{C}$ | | |
| T_{stg} | Storage Temperature Range | -55 to +175 | $^\circ\text{C}$ | | |

Package


TO-220-2



Silicon Carbide Schottky Diode
Electrical Characteristics

| Symbol | Parameter | Typ. | Max. | Unit | Test Conditions | Note |
|--------|---------------------------|-----------------|-------------|---------------|--|--------|
| V_F | Forward Voltage | 1.41 1.8 | 1.65 2.4 | V | $I_F = 4\text{ A}, T_J = 25\text{ }^\circ\text{C}$ $I_F = 4\text{ A}, T_J = 175\text{ }^\circ\text{C}$ | Fig. 1 |
| I_R | Reverse Current | 2 10 | 30 100 | μA | $V_R = 650\text{ V}, T_J = 25\text{ }^\circ\text{C}$ $V_R = 650\text{ V}, T_J = 175\text{ }^\circ\text{C}$ | Fig. 2 |
| Q_C | Total Capacitive Charge | 11 | | nC | $V_R = 400\text{ V}, I_F = 4\text{ A},$ $T_J = 25\text{ }^\circ\text{C}$ | Fig. 6 |
| C | Total Capacitance | 213 22 17 | | pF | $V_R = 0\text{ V}, T_J = 25\text{ }^\circ\text{C}, f = 1\text{ MHz}$ $V_R = 200\text{ V}, T_J = 25\text{ }^\circ\text{C}, f = 1\text{ MHz}$ $V_R = 400\text{ V}, T_J = 25\text{ }^\circ\text{C}, f = 1\text{ MHz}$ | Fig. 5 |
| E_C | Capacitance Stored Energy | 1.5 | | μJ | $V_R = 400\text{ V}$ | Fig. 7 |

Note: This is a majority carrier diode, so there is no reverse recovery charge.

Thermal Characteristics

| Symbol | Parameter | Min. | Typ. | Max. | Unit | Note |
|-----------------|--|------|------|------|--------------------|-------|
| $R_{\theta JC}$ | Thermal Resistance from Junction to Case | | 2.9 | | $^\circ\text{C/W}$ | Fig.8 |

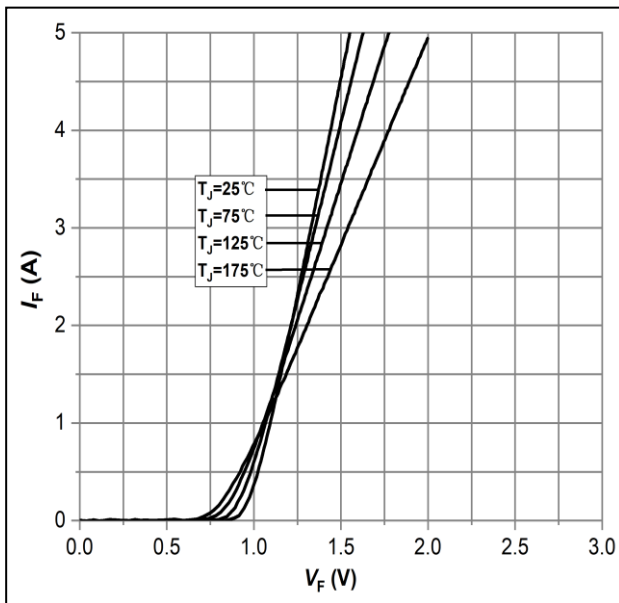
Typical Performance


Figure 1: Forward Characteristics

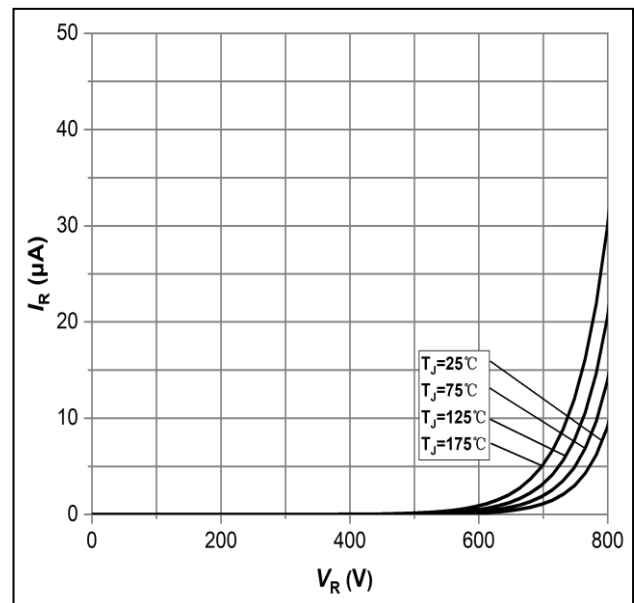


Figure 2: Reverse Characteristics

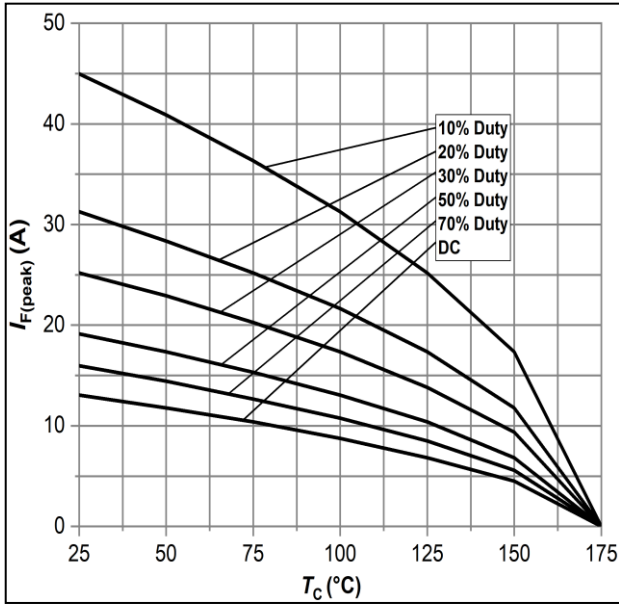
Silicon Carbide Schottky Diode
Typical Performance


Figure 3: Current Derating

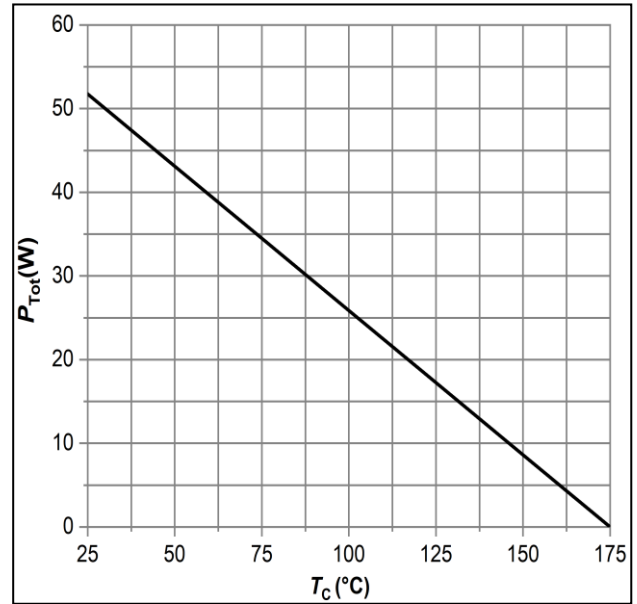


Figure 4: Power Derating

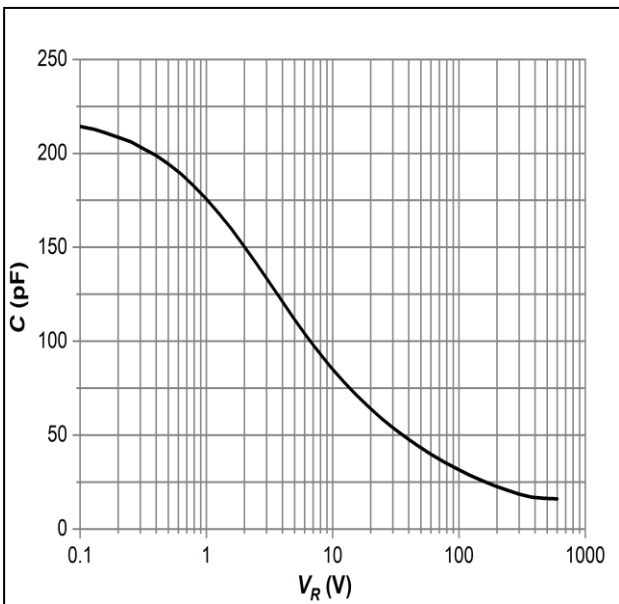


Figure 5: Capacitance vs. Reverse Voltage

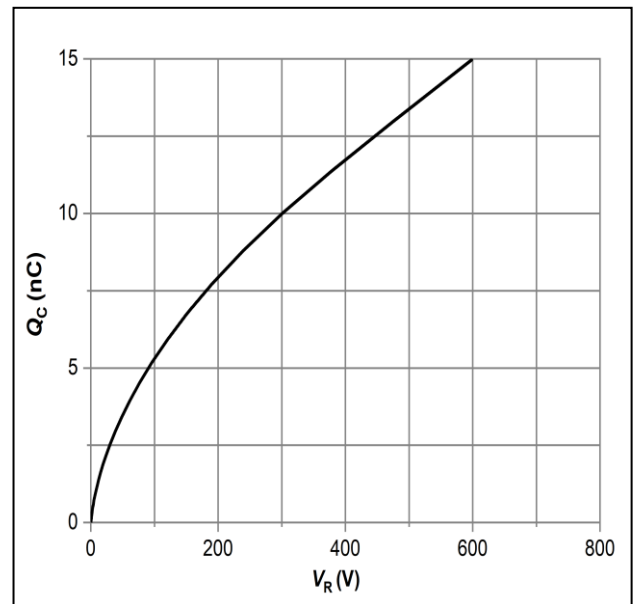


Figure 6: Total Capacitance Charge vs. Reverse Voltage

Silicon Carbide Schottky Diode

Typical Performance

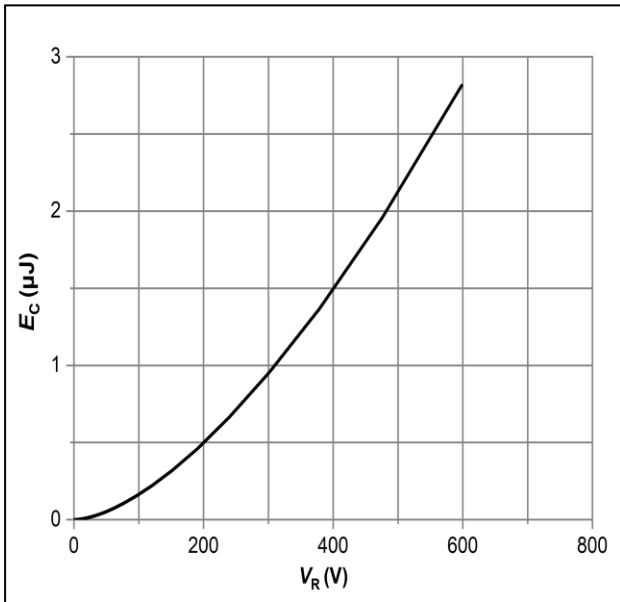


Figure 7: Typical Capacitance Stored Energy

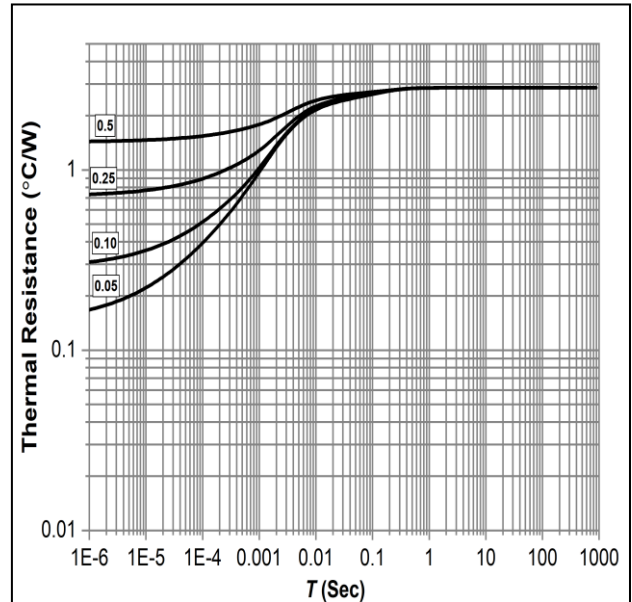
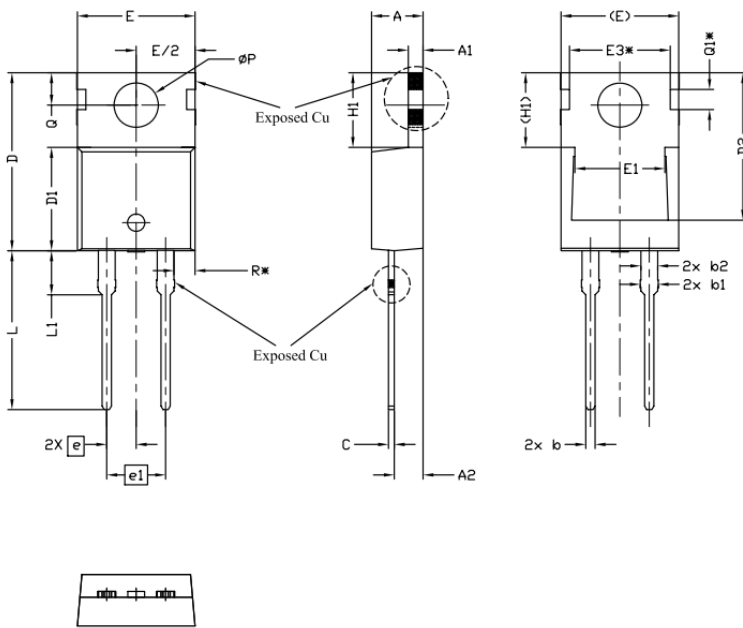


Figure 8: Transient Thermal Impedance

Silicon Carbide Schottky Diode
Package Dimensions

Package: TO-220-2



| SYMBOL | DIMENSIONS | | | NOTES |
|----------|------------|-------|-------|-------|
| | Min. | NOM | Max. | |
| A | 4.24 | 4.44 | 4.64 | |
| A1 | 1.15 | 1.27 | 1.40 | |
| A2 | 2.30 | 2.48 | 2.70 | |
| b | 0.70 | 0.80 | 0.90 | |
| b1 | 1.20 | 1.55 | 1.75 | |
| b2 | 1.20 | 1.45 | 1.70 | |
| c | 0.40 | 0.50 | 0.60 | |
| D | 14.70 | 15.37 | 16.00 | 4 |
| D1 | 8.82 | 8.92 | 9.02 | |
| D2 | 12.43 | 12.73 | 12.83 | 5 |
| E | 9.96 | 10.16 | 10.36 | 4.5 |
| E1 | 6.86 | 7.77 | 8.89 | 5 |
| E3* | 8.70 REF | | | |
| e | 2.54 BSC | | | |
| e1 | 5.08 BSC | | | |
| H1 | 6.30 | 6.45 | 6.60 | 5.6 |
| L | 13.47 | 13.72 | 13.97 | |
| L1 | 3.60 | 3.80 | 4.00 | |
| ϕP | 3.75 | 3.84 | 3.93 | |
| Q | 2.60 | 2.80 | 3.00 | |
| Q1* | 1.73 REF | | | |
| R* | 1.82 REF | | | |

NOTE : Dimension L, M, W apply for Solder Dip Finish